

WRAPPING THE WORLD IN PEACE



THE PEACE FLAG PROJECT

www.peace-activism.org

We live in unprecedented times.

Times where a virus has broken boundaries and got us to realize that we are only human.

Governments and people are joining hands to fight the pandemic.

Yet, the world remains divided

The power lies in our hands to make this world a better place, leaving no one behind.

The Peace Flag project works with the Sustainable Development Goal 16- Peace, Justice and Strong institutions.

The Peace Resolution was passed by the City Council of Half Moon Bay California in September 2020 to honor of the Peace Flag Project.

The Flag connects 193 countries.

Flags collected from countries around the world will join the main flag, to be displayed annually at the United Nations, on the International Day of Peace.

As the flag continues to grow, every Art work and person becomes a part of its history.

Be an Advocate for Peace. Join the Peace Flag

THE FLAG MAKING PROCESS



THE CREATORS

~CREATE THE CANVAS

~HAND IT OVER TO YOUR CO-ORDINATOR

THE CO-ORDINATOR

~COLLECT THE CANVASES

~GROUP THE CANVASES

~DISPLAY THE CANVASES AKA THE FLAG

~PHOTOGRAPH THE FLAG

~POST THE FLAG TO THE ORGANIZING COMMITTEE

~PROVIDE POSTAL RECEIPT FOR REIMBURSEMENT

TABLE OF CONTENTS

CREATING THE ART WORK	_____	1
WAYS TO GROUP THE CANVASES	_____	2
1. Safety Pins	2
2. Collage	3
3. Sewing	4
<i>Stitching the canvases- A</i>	5
<i>Creating Panels- B</i>	6
<i>Installing the Flag- C</i>	6
DISPLAYING THE FLAG	_____	7
TAKING PHOTOS	_____	8
STRAIGHT SHOTS	_____	9
THE OVER HEAD SHOT	_____	10

CREATING THE ART WORK



STEP -1



Take any old T shirt, pillow case or fabric that might end up in the land fill

STEP -2

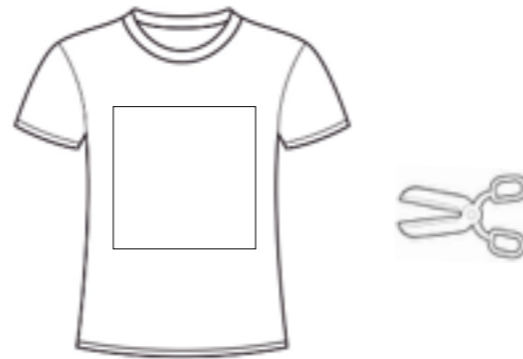

Find the plain side and Cut out a square of 12"x 12" inches

STEP -3

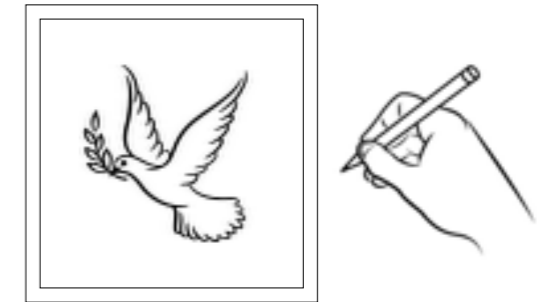

Draw,write. paint, stick what Peace means to you on your canvas

Leave a margin of 1 inch all around your art work

Sign with your name
date, city/country

STEP -4



Hand over the canvas to your co-ordinator

WAYS TO GROUP THE CANVASES



1. Safety Pins

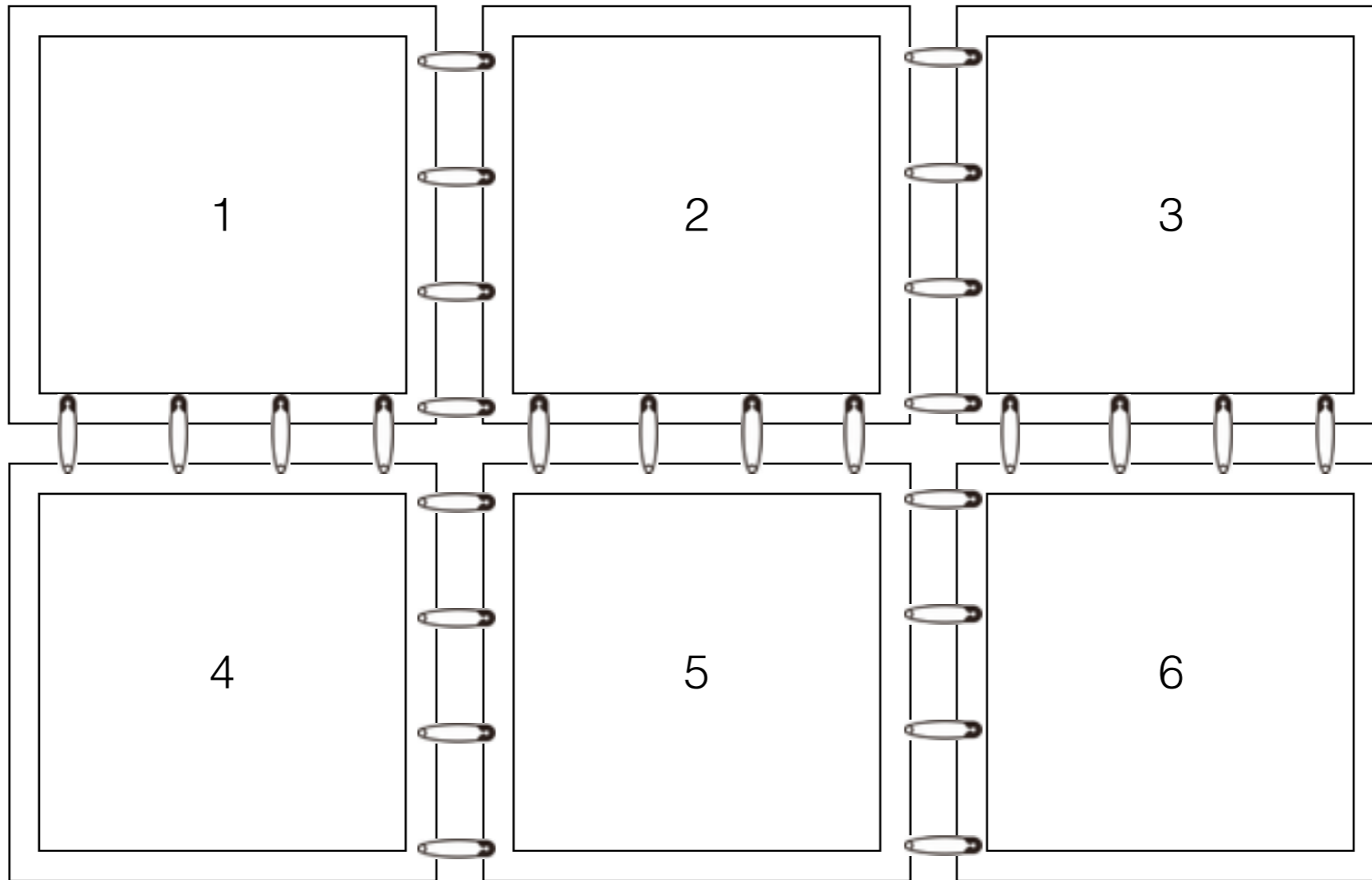

Using safety pins connect the sides of the canvases to create the flag

2. Collage



1	2	3
4	5	6
7	8	9

Lay the canvases next to each other on the ground to create a collage

3. Sewing



Stitching the canvases

A

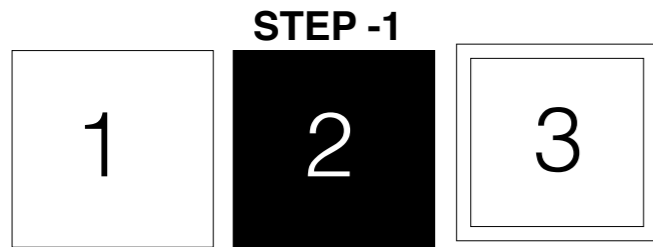

Collect the Canvases



Overlap the right side of 2 facing the right side of 1

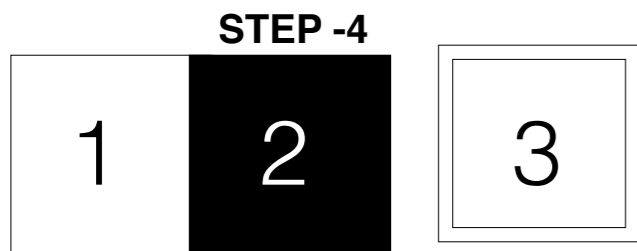
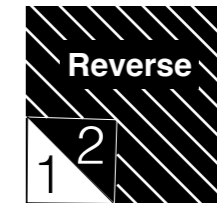

Repeat step 2 using canvas 3



Unfold the Canvases

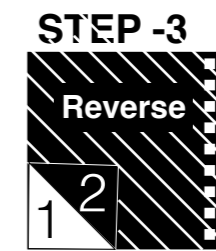

Sew the edges of 1 and 2 together



overlap canvas 3 on canvas 2 right side facing the right side

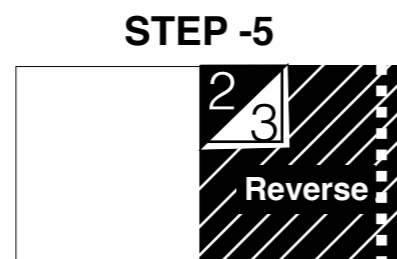

Sew the edges of canvas 2 and 3 together

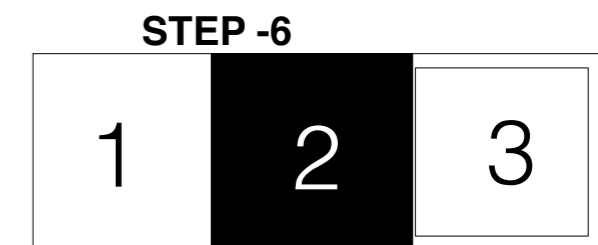

Unfold the panel
Repeat the process with the other canvases

Creating Panels

B



Stitch canvases together to create separate panels

Panel-1

1	2	3	4	5	6	7	8	9	10
---	---	---	---	---	---	---	---	---	----

Panel-2

11	12	13	14	15	16	17	18	19	20
----	----	----	----	----	----	----	----	----	----

Overlap panel 1 and 2
right side facing right side



Sew the edges of the 1st and 2nd panel together



Open up the Panels

1	2	3	4	5	6	7	8	9	10
11	12	13	14	15	16	17	18	19	20

Repeat step 1 and 2 for the remainder of the panels to create a flag

Installing the Flag

C



PEACE
ACTIVISM

Cut 2 lengths of fabric similar to the length of the panel

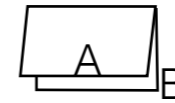
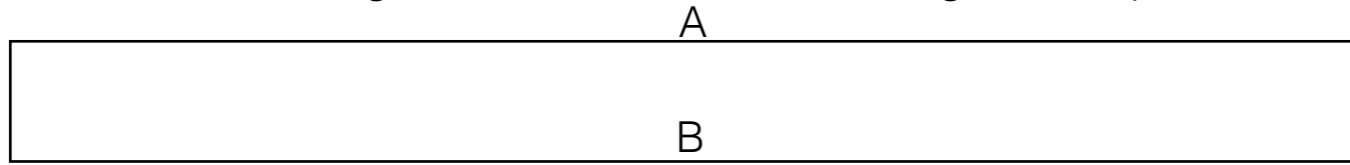

Fold in half

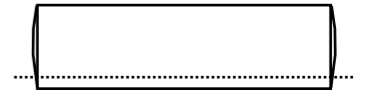

sew edges A and B together and create a funnel

Attach the funnel at the top and bottom edge of the flag

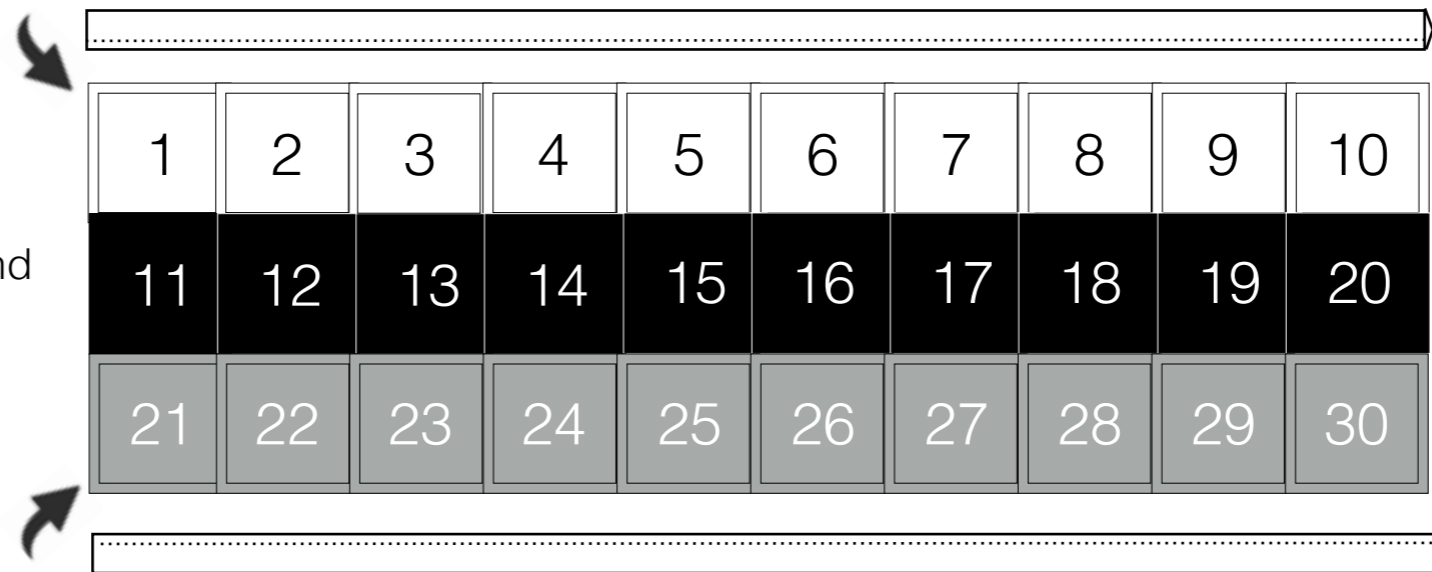

INSERT RODS

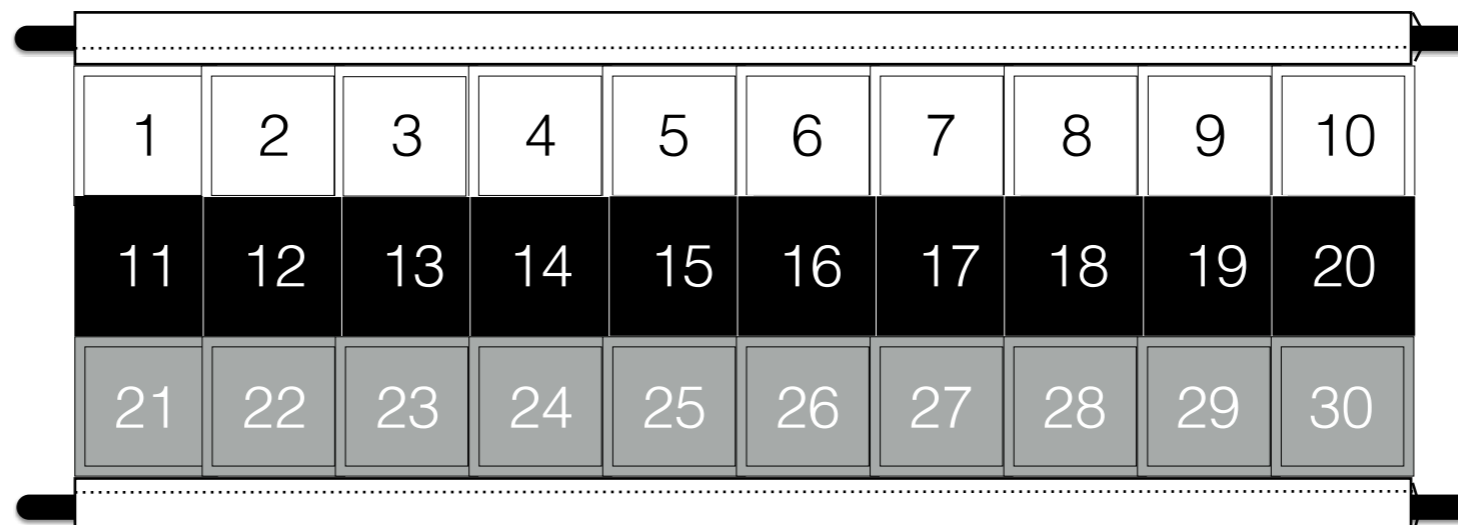

DISPLAYING THE FLAG



PEACE
ACTIVISM

1	2	3	4	5	6	7	8	9	10
11	12	13	14	15	16	17	18	19	20
21	22	23	24	25	26	27	28	29	30



Country
State- City
(Name of Institution)
Date
#peace-activism
#World Beyond War

A poster bearing the Name of the Country- State- City,
Name of the participating Institution-Date and # URI #peace-activism.

To be placed below the Flag which is either hung or displayed flat.



The poster along with the flag to be photographed

TAKING PHOTOS

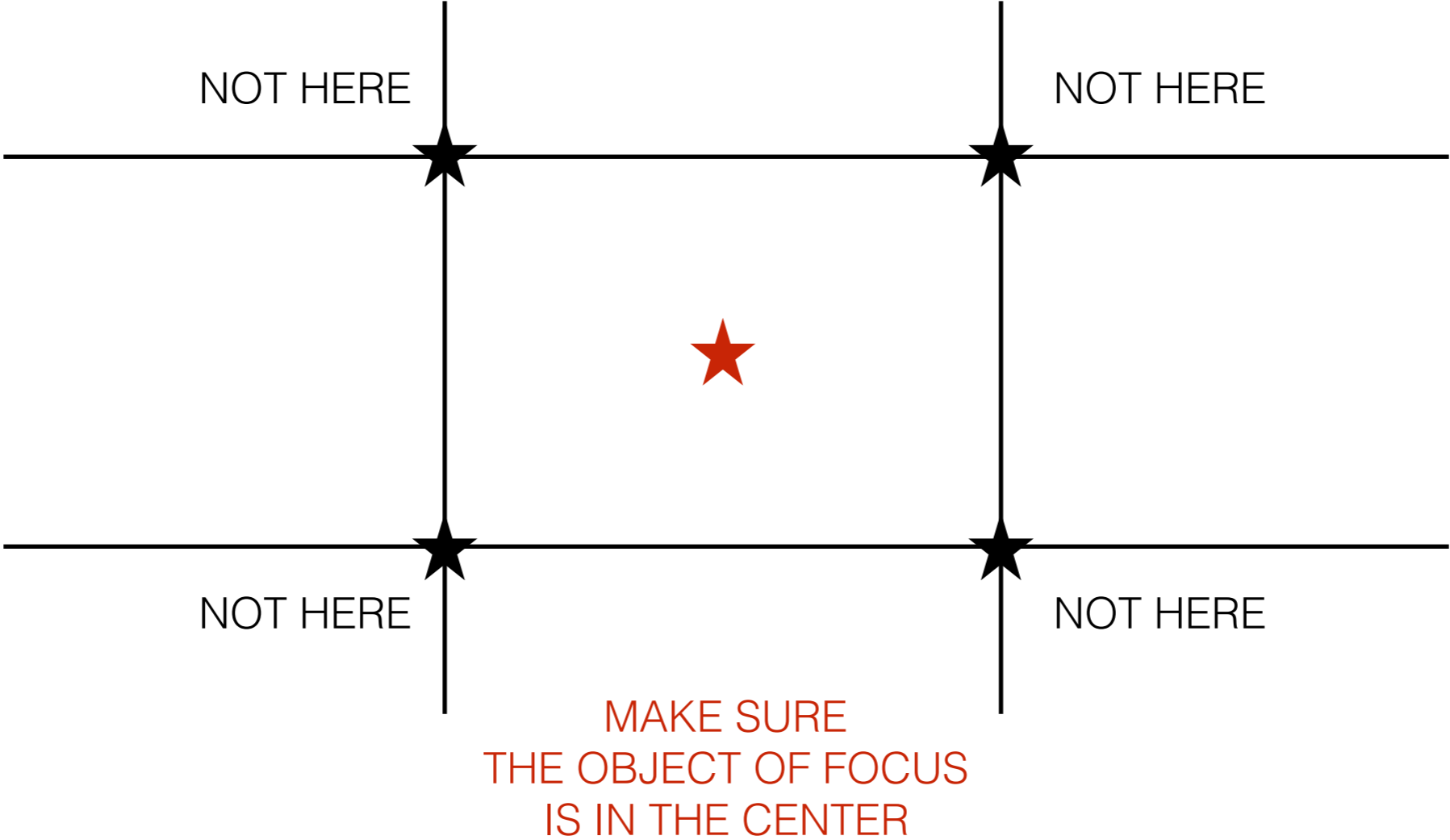

STRAIGHT SHOTS



If you have the flag Displayed on a wall

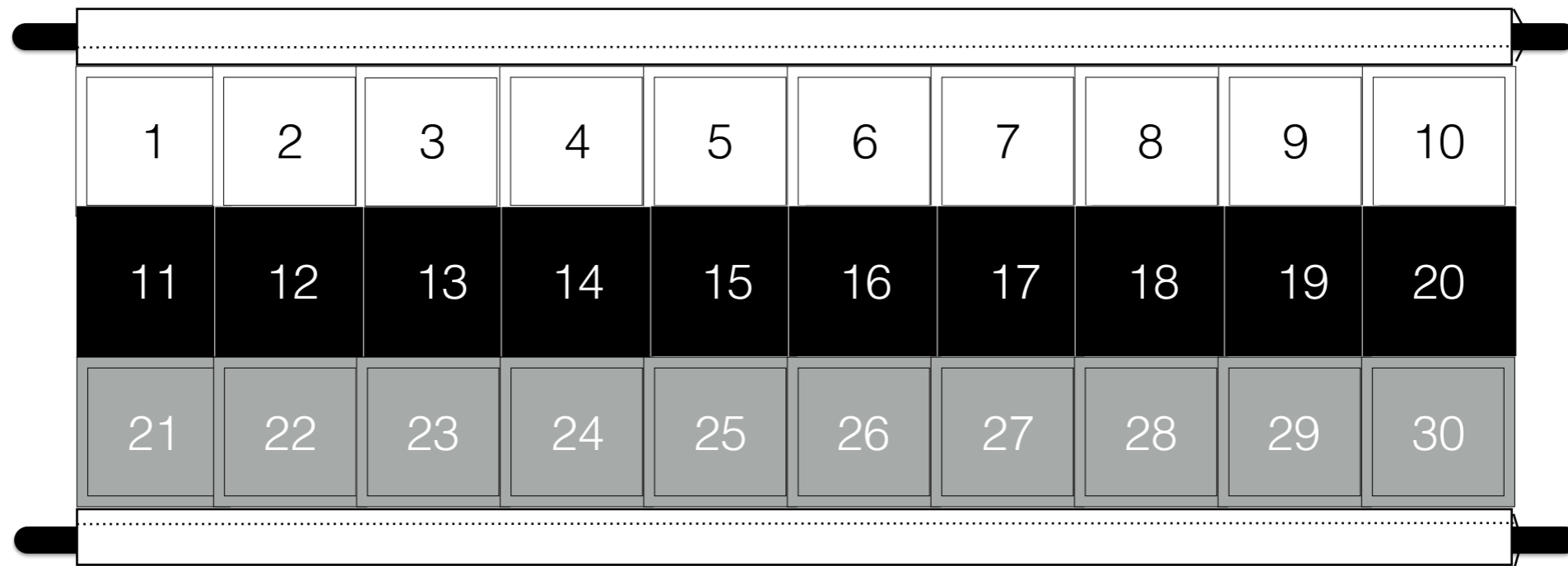

Position the camera in the center and try to capture the entire flag



wrong angle

X



correct angle



wrong angle

X

9

THE OVER HEAD SHOT

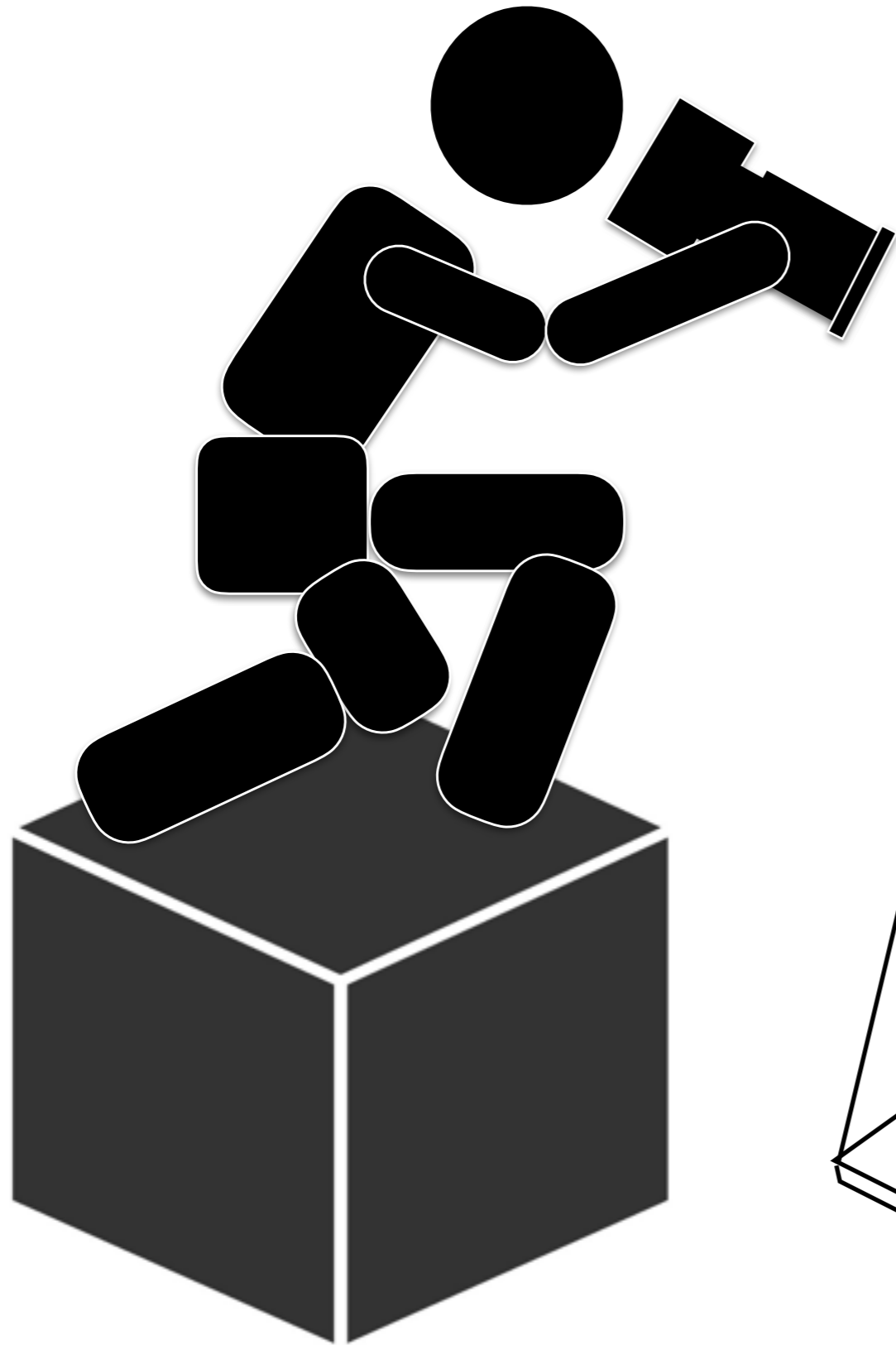

If you have the flag placed on the ground

- Get yourself on an elevated platform*
- Try to capture the entire image of the canvases placed together*
- Use a wide angle lens*
- Try to capture the canvases close up with your camera*

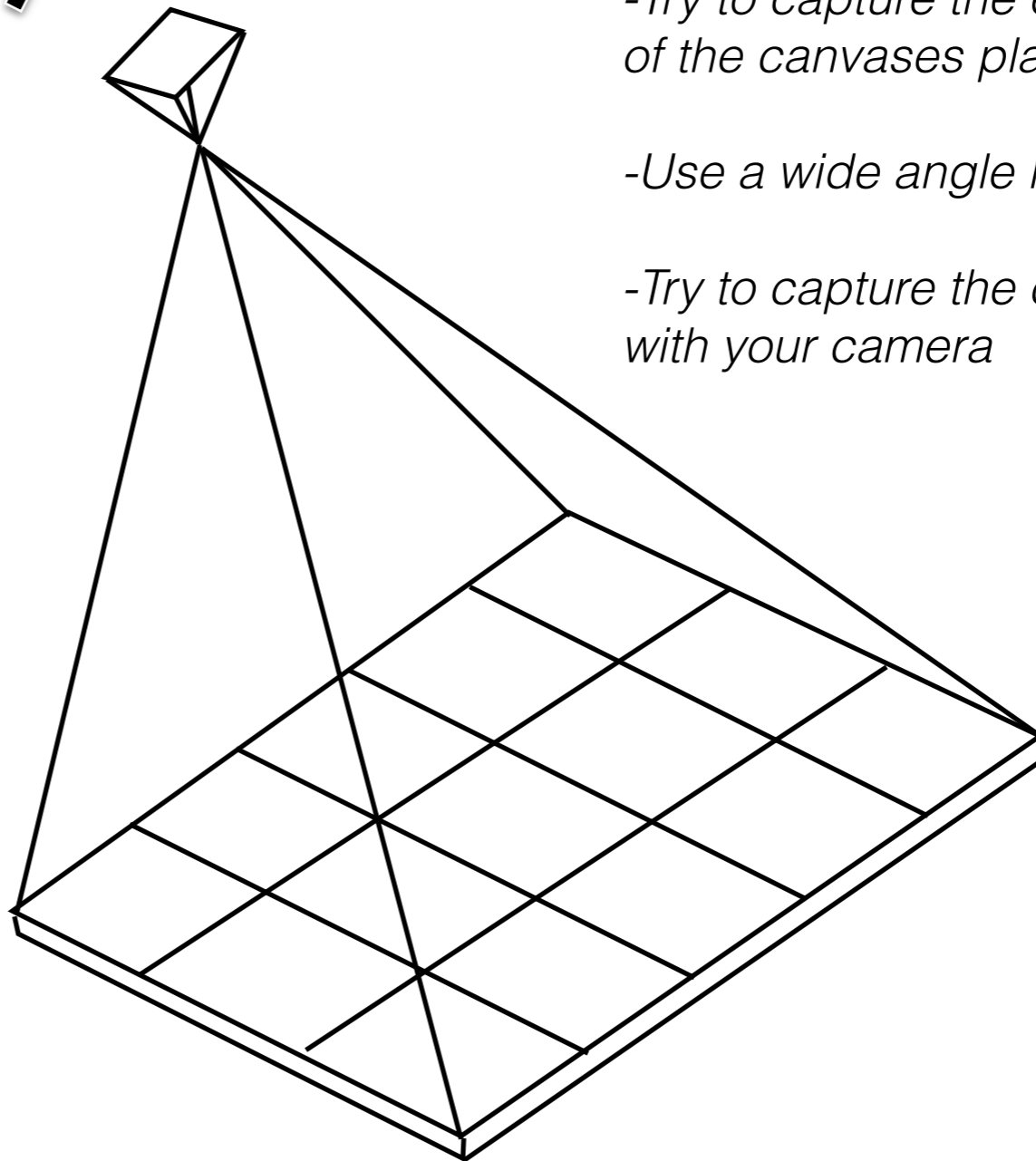



Contact your local Councils, Magistrate, Municipalities and express your wish to hang the Flag in the City Square, or a prominent location to raise awareness about Peace.

You might need a protective cover if you are displaying the flag outdoors, to protect it from the elements

If you cannot find a public location, you can display the Flag at any place of convenience

Take Photos of your Flag display, and work in progress.
E-mail to *activismpeace@gmail.com*

Try to gather a minimum of 100 canvases to form a flag

After the display, mail the Flag/ canvases to the following address

**Peace-Activism
430 Beach Avenue
Half Moon Bay
California 94019
United States of America**

Please provide the Postal Receipt for which you will be reimbursed

This booklet of instructions may not be reproduced without written consent from Peace-activism

OUR SUPPORTING PARTNERS

Endorser of the Peace Pledge at



WORLD **BEYOND** WAR.org
a global movement to end all wars



In association with the
Sustainable Development Goals
United Nations